

UM RapidDrill

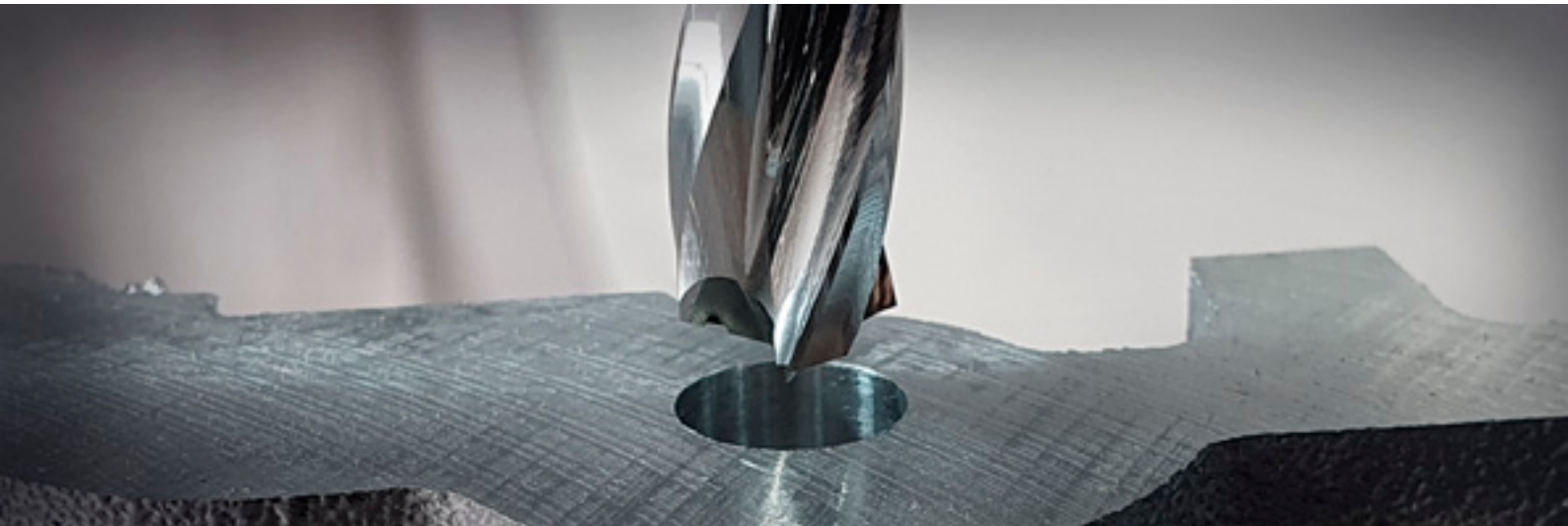

Solid carbide drill for aluminium

High efficient drilling in aluminium alloys

- High speed machining
- Excellent hole quality
- Standard and customised dimensions available



For process robustness and high performance

UM RapidDrill

With 3 cutting edges and polished flutes UM RapidDrill provides robustness with very high penetration rates. Both standard and special geometries are available.

150° point angle

Optimised cutting geometries and special designed point angle.

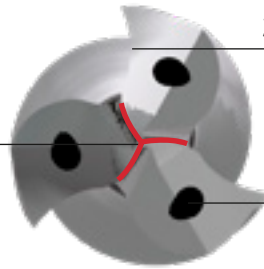

3 cutting edges

High performance machining with 3 cutting edges

Internal coolant

Integrated coolant provides smooth machining and extended tool life

Styles available Tool range

Standard

General purpose design with internal coolant.

Diameter range

5xD

8xD

12xD

Ø4,0 - Ø20 mm

Cutting diameters available in 0.1 mm increments.



Customised

Get your special designed UM RapidDrill solution with optional diameters, step and coolant holes*.

Diameter range of your choice

≤12xD

Ø3,3 - Ø32 mm

Cutting diameters available in 0.1 mm increments.
* Customised UM RapidDrill without internal coolant optional.



Highlights

- Standard and customised dimensions
- Easy cutting geometries
- Polished flutes
- Internal coolant
- Special 150° point angle
- Up to 5 times Re-New
- Up to 700.000 holes
- Available from Ø3,3 mm to Ø32 mm





1 Recommended solution for smooth machining and high quality finishing

For efficient process and high performance machining*

Standard series and special designed drills for processing robustness with very high penetration rates

UM RapidDrill is designed for demanding and challenging applications in aluminium alloys.

Its main features are process robustness and excellent hole quality when drilling with high penetration rates.

The high penetration rates and extended service life results in lower production costs.

** Also suitable for machines with limited torque available.*



On average UM RapidDrill is **4x closer** to the target diameter than competitor tools, even when feed rate is increased.

Applications

Great hole quality on straight plans

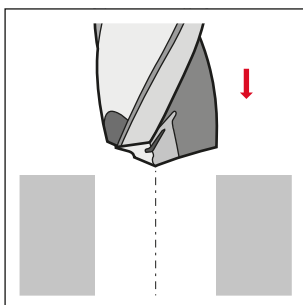

Through holes

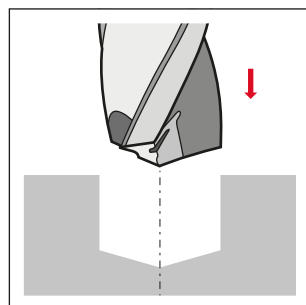

Bottom holes

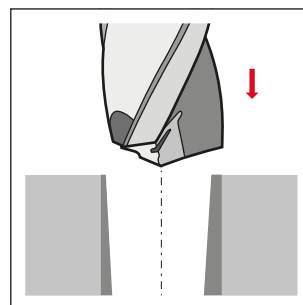

Precast holes

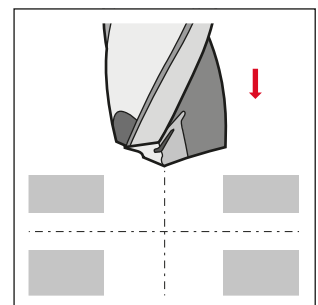

Cross hole

2 Tool performance and hole quality

High speed machining

Material

■ 6082 T6

Comparing in equal test conditions shows, that the efficiency from UM RapidDrill is greater, while maintaining excellent hole quality - even when feed rate is increased.

Drilling speed $V_c=300 / F=0,4 \cdot \varnothing 8,0$ mm

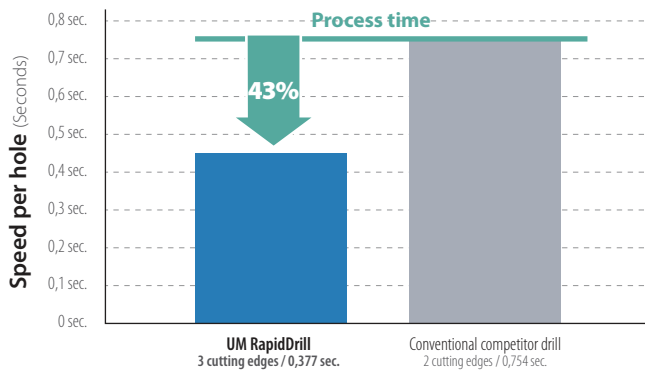

Comparing performance levels reveals UM RapidDrill is machining **43% faster** than conventional drills with 2 cutting edges operating within recommended cutting data.

Hole straightness $V_c=300 / F=0,4 \cdot \varnothing 8,0$ mm • Drilling depth 30 mm

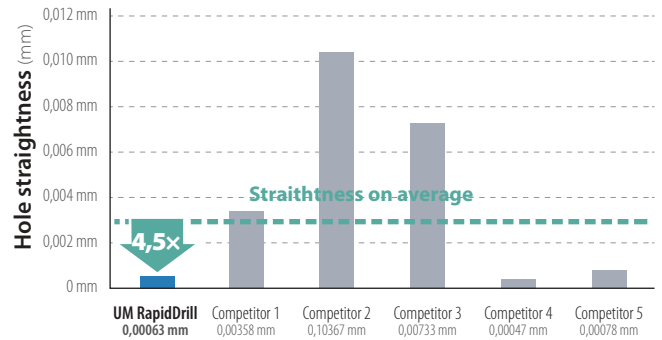

Hole straightness is **4,5 x straighter** than competitor tools on average – even when feed rate is increased.

Average roundness Internal test

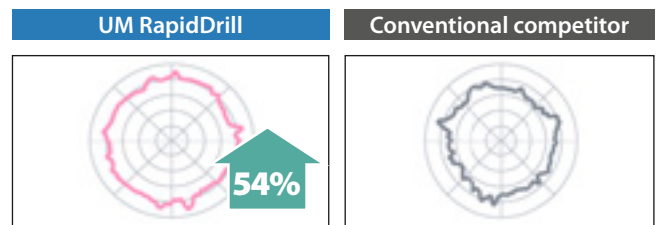

On average UM RapidDrill creates **54% better** hole roundness than compared competitor tools.

Polished surfaces



Easy cutting geometries



Special 150° point angle

3 Chip length and burr formation

UM RapidDrill compared to competitors

Even at increased and very high feed rates UM RapidDrill is outperforming most competitors - and under the right conditions, it even outperforms itself.

Chip quality $V_c=300 / F=0,4 \cdot \varnothing 8,0$ mm

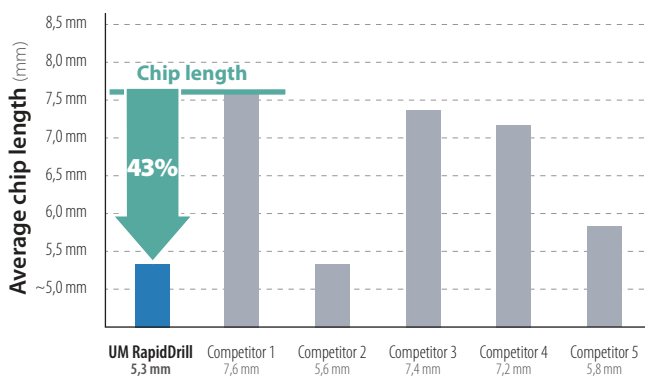

The average chips are **27% shorter**, when using UM RapidDrill. Even at high feed rate, UM RapidDrill still outperforms most competitors.



UM RapidDrill chips • F/mm: 0,4



Average surface roughness is **20% better** than compared competitor drills.

Burr formation Internal test

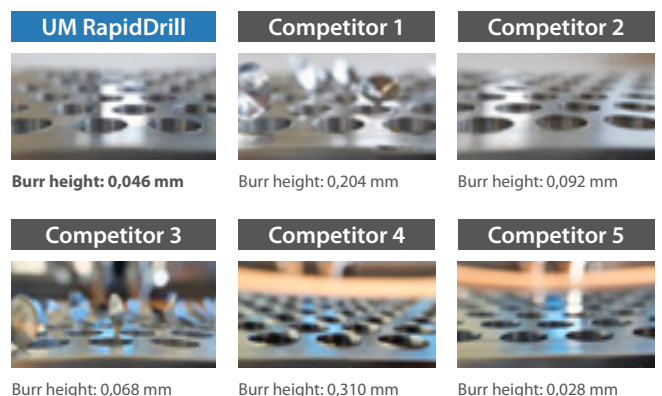

UM RapidDrill has an **85% reduced** exit burr height - even when the feed is more than doubled.

When standard doesn't cut it



Customised UM RapidDrill

Unique tools on demand

Expertise and Tool Decider

Standard solutions may not always work. Sometimes you need a customised solution that has been tailored to your specific production situation. This include special geometries on point thinning, edge preparation and the possibility for step length variations. To do this, our consultants combine their expertise, know-how – and a software called Tool Decider.

Geometries on demand

With Tool Decider, we can rapidly customise specific special UM RapidDrill solutions on request, that matches your need.

When customising solutions we successfully meet your specific requirements with tool design and optimised cutting performance through adjusted cutting data.

UM RapidDrill with special geometry can be delivered within **10 working days**.

Special design made easy Tool Decider

With Tool Decider we have optimised our work flow all the way from your request to shipping the tools.

- Always high quality tools
- Guaranteed short delivery time
- Competitive price vs. performance ratio
- Optimised tool solution for each application

10 DAYS DELIVERY

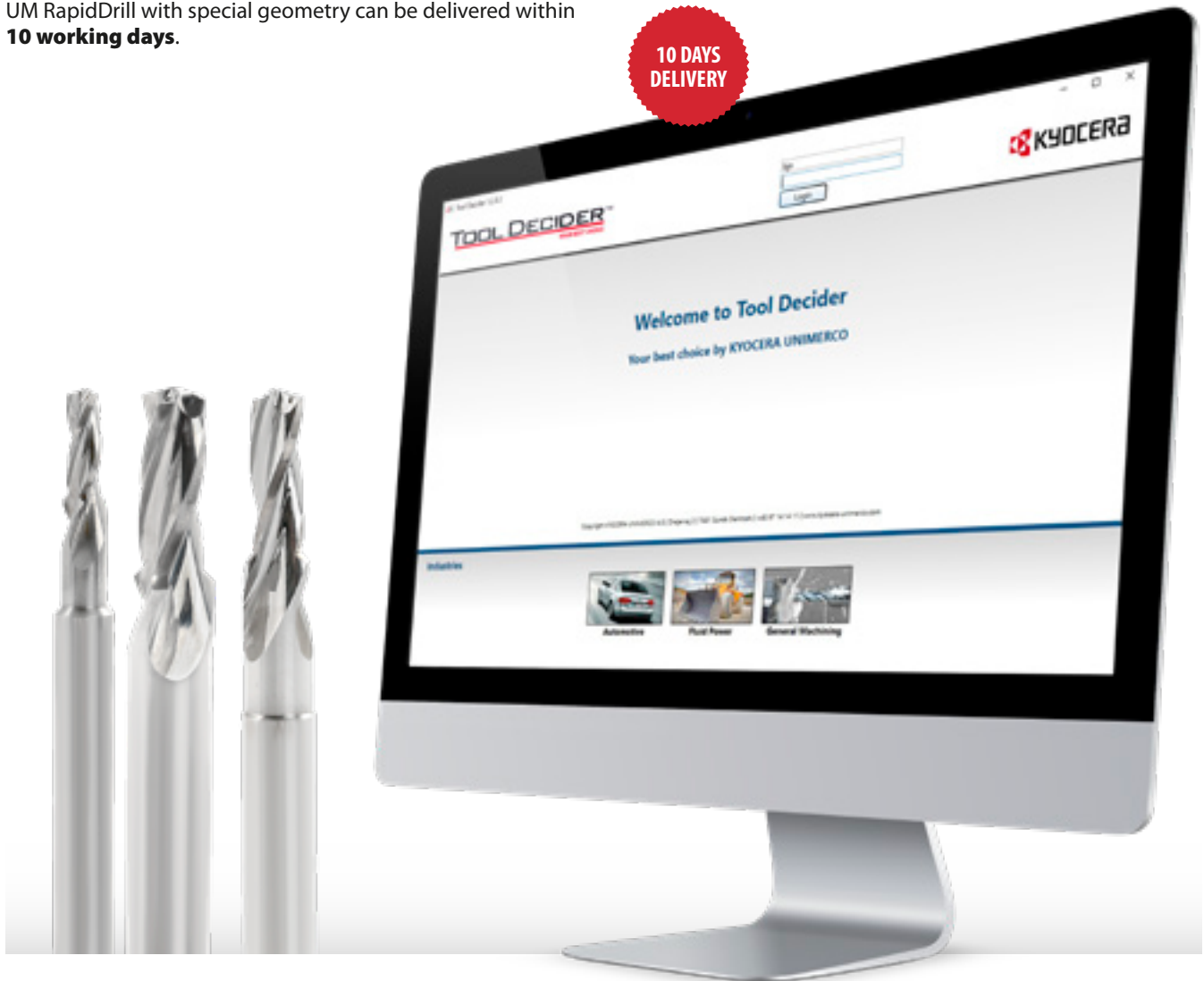

How it works Four simple steps to get your special designed tool





UM RapidDrill

AROUND THE DRILL

- Standard dimensions from $\varnothing 4$ mm up
- Customised dimensions from $\varnothing 3,3$ mm up
- Polished flutes
- Easy cutting geometries
- 3 cutting edges
- Special 150° point angle
- Internal coolant
- Keeps hole quality at increased cutting speeds



5xD

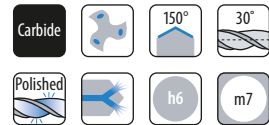
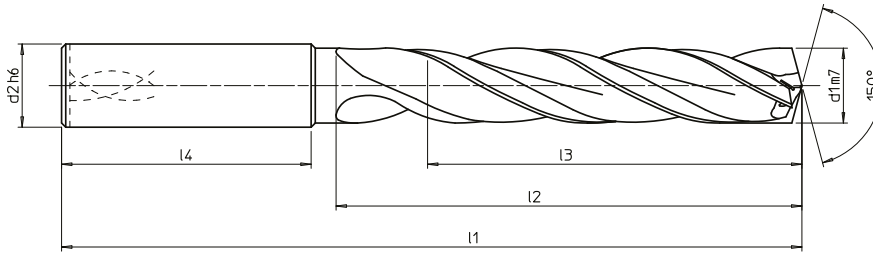

■ Optimum solution for Non-Ferrous Metal

d1 (mm)	d1 (inch)	d2	l1	l2	l3	l4	Description	Item no.
4,00		6	74	36	29	36	4.00 5xD IC Z3 S6	258870.0400
4,10		6	74	36	29	36	4.10 5xD IC Z3 S6	258870.0410
4,20		6	74	36	29	36	4.20 5xD IC Z3 S6	258870.0420
4,30		6	74	36	29	36	4.30 5xD IC Z3 S6	258870.0430
4,37	11/64	6	74	36	29	36	4.37 5xD IC Z3 S6	258870.0437
4,40		6	74	36	29	36	4.40 5xD IC Z3 S6	258870.0440
4,50		6	74	36	29	36	4.50 5xD IC Z3 S6	258870.0450
4,60		6	74	36	29	36	4.60 5xD IC Z3 S6	258870.0460
4,70		6	74	36	29	36	4.70 5xD IC Z3 S6	258870.0470
4,76	3/16	6	82	44	35	36	4.76 5xD IC Z3 S6	258870.0476
4,80		6	82	44	35	36	4.80 5xD IC Z3 S6	258870.0480
4,90		6	82	44	35	36	4.90 5xD IC Z3 S6	258870.0490
5,00		6	82	44	35	36	5.00 5xD IC Z3 S6	258870.0500
5,10		6	82	44	35	36	5.10 5xD IC Z3 S6	258870.0510
5,16	13/64	6	82	44	35	36	5.16 5xD IC Z3 S6	258870.0516
5,20		6	82	44	35	36	5.20 5xD IC Z3 S6	258870.0520
5,30		6	82	44	35	36	5.30 5xD IC Z3 S6	258870.0530
5,40		6	82	44	35	36	5.40 5xD IC Z3 S6	258870.0540
5,50		6	82	44	35	36	5.50 5xD IC Z3 S6	258870.0550
5,56	7/32	6	82	44	35	36	5.56 5xD IC Z3 S6	258870.0556
5,60		6	82	44	35	36	5.60 5xD IC Z3 S6	258870.0560
5,70		6	82	44	35	36	5.70 5xD IC Z3 S6	258870.0570
5,80		6	82	44	35	36	5.80 5xD IC Z3 S6	258870.0580
5,90		6	82	44	35	36	5.90 5xD IC Z3 S6	258870.0590
5,95	15/64	6	82	44	35	36	5.95 5xD IC Z3 S6	258870.0595
6,00		6	82	44	35	36	6.00 5xD IC Z3 S6	258870.0600
6,10		8	91	53	43	36	6.10 5xD IC Z3 S8	258870.0610
6,20		8	91	53	43	36	6.20 5xD IC Z3 S8	258870.0620
6,30		8	91	53	43	36	6.30 5xD IC Z3 S8	258870.0630
6,35	1/4	8	91	53	43	36	6.35 5xD IC Z3 S8	258870.0635
6,40		8	91	53	43	36	6.40 5xD IC Z3 S8	258870.0640
6,50		8	91	53	43	36	6.50 5xD IC Z3 S8	258870.0650
6,60		8	91	53	43	36	6.60 5xD IC Z3 S8	258870.0660
6,70		8	91	53	43	36	6.70 5xD IC Z3 S8	258870.0670

d1 (mm)	d1 (inch)	d2	l1	l2	l3	l4	Description	Item no.
6,75	17/64	8	91	53	43	36	6.75 5xD IC Z3 S8	258870.0675
6,80		8	91	53	43	36	6.80 5xD IC Z3 S8	258870.0680
6,90		8	91	53	43	36	6.90 5xD IC Z3 S8	258870.0690
7,00		8	91	53	43	36	7.00 5xD IC Z3 S8	258870.0700
7,10		8	91	53	43	36	7.10 5xD IC Z3 S8	258870.0710
7,14	9/32	8	91	53	43	36	7.14 5xD IC Z3 S8	258870.0714
7,20		8	91	53	43	36	7.20 5xD IC Z3 S8	258870.0720
7,30		8	91	53	43	36	7.30 5xD IC Z3 S8	258870.0730
7,40		8	91	53	43	36	7.40 5xD IC Z3 S8	258870.0740
7,50		8	91	53	43	36	7.50 5xD IC Z3 S8	258870.0750
7,54	19/64	8	91	53	43	36	7.54 5xD IC Z3 S8	258870.0754
7,60		8	91	53	43	36	7.60 5xD IC Z3 S8	258870.0760
7,70		8	91	53	43	36	7.70 5xD IC Z3 S8	258870.0770
7,80		8	91	53	43	36	7.80 5xD IC Z3 S8	258870.0780
7,90		8	91	53	43	36	7.90 5xD IC Z3 S8	258870.0790
7,94	5/16	8	91	53	43	36	7.94 5xD IC Z3 S8	258870.0794
8,00		8	91	53	43	36	8.00 5xD IC Z3 S8	258870.0800
8,10		10	103	61	49	40	8.10 5xD IC Z3 S10	258870.0810
8,20		10	103	61	49	40	8.20 5xD IC Z3 S10	258870.0820
8,30		10	103	61	49	40	8.30 5xD IC Z3 S10	258870.0830
8,33	21/64	10	103	61	49	40	8.33 5xD IC Z3 S10	258870.0833
8,40		10	103	61	49	40	8.40 5xD IC Z3 S10	258870.0840
8,50		10	103	61	49	40	8.50 5xD IC Z3 S10	258870.0850
8,60		10	103	61	49	40	8.60 5xD IC Z3 S10	258870.0860
8,70		10	103	61	49	40	8.70 5xD IC Z3 S10	258870.0870
8,73	11/32	10	103	61	49	40	8.73 5xD IC Z3 S10	258870.0873
8,80		10	103	61	49	40	8.80 5xD IC Z3 S10	258870.0880
8,90		10	103	61	49	40	8.90 5xD IC Z3 S10	258870.0890
9,00		10	103	61	49	40	9.00 5xD IC Z3 S10	258870.0900
9,10		10	103	61	49	40	9.10 5xD IC Z3 S10	258870.0910
9,13	23/64	10	103	61	49	40	9.13 5xD IC Z3 S10	258870.0913
9,20		10	103	61	49	40	9.20 5xD IC Z3 S10	258870.0920
9,30		10	103	61	49	40	9.30 5xD IC Z3 S10	258870.0930
9,40		10	103	61	49	40	9.40 5xD IC Z3 S10	258870.0940

5xD

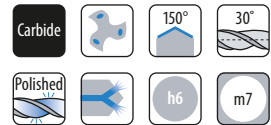
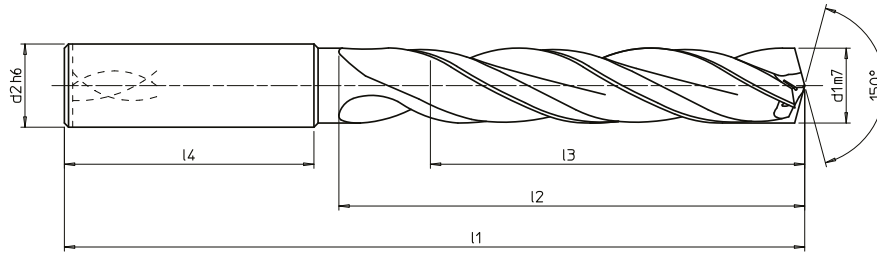

■ Optimum solution for Non-Ferrous Metal

d1 (mm)	d1 (inch)	d2	l1	l2	l3	l4	Description	Item no.
9,50		10	103	61	49	40	9.50 5xD IC Z3 S10	258870.0950
9,53	3/8	10	103	61	49	40	9.53 5xD IC Z3 S10	258870.0953
9,60		10	103	61	49	40	9.60 5xD IC Z3 S10	258870.0960
9,70		10	103	61	49	40	9.70 5xD IC Z3 S10	258870.0970
9,80		10	103	61	49	40	9.80 5xD IC Z3 S10	258870.0980
9,90		10	103	61	49	40	9.90 5xD IC Z3 S10	258870.0990
9,92	25/64	10	103	61	49	40	9.92 5xD IC Z3 S10	258870.0992
10,00		10	103	61	49	40	10.00 5xD IC Z3 S10	258870.1000
10,10		12	118	71	56	45	10.10 5xD IC Z3 S12	258870.1010
10,20		12	118	71	56	45	10.20 5xD IC Z3 S12	258870.1020
10,30		12	118	71	56	45	10.30 5xD IC Z3 S12	258870.1030
10,32	13/32	12	118	71	56	45	10.32 5xD IC Z3 S12	258870.1032
10,40		12	118	71	56	45	10.40 5xD IC Z3 S12	258870.1040
10,50		12	118	71	56	45	10.50 5xD IC Z3 S12	258870.1050
10,60		12	118	71	56	45	10.60 5xD IC Z3 S12	258870.1060
10,70		12	118	71	56	45	10.70 5xD IC Z3 S12	258870.1070
10,72	27/64	12	118	71	56	45	10.72 5xD IC Z3 S12	258870.1072
10,80		12	118	71	56	45	10.80 5xD IC Z3 S12	258870.1080
10,90		12	118	71	56	45	10.90 5xD IC Z3 S12	258870.1090
11,00		12	118	71	56	45	11.00 5xD IC Z3 S12	258870.1100
11,10		12	118	71	56	45	11.10 5xD IC Z3 S12	258870.1110
11,11	7/16	12	118	71	56	45	11.11 5xD IC Z3 S12	258870.1111
11,20		12	118	71	56	45	11.20 5xD IC Z3 S12	258870.1120
11,30		12	118	71	56	45	11.30 5xD IC Z3 S12	258870.1130
11,40		12	118	71	56	45	11.40 5xD IC Z3 S12	258870.1140
11,50		12	118	71	56	45	11.50 5xD IC Z3 S12	258870.1150
11,60		12	118	71	56	45	11.60 5xD IC Z3 S12	258870.1160
11,70		12	118	71	56	45	11.70 5xD IC Z3 S12	258870.1170
11,80		12	118	71	56	45	11.80 5xD IC Z3 S12	258870.1180
11,90		12	118	71	56	45	11.90 5xD IC Z3 S12	258870.1190
12,00		12	118	71	56	45	12.00 5xD IC Z3 S12	258870.1200
12,50		14	124	77	60	45	12.50 5xD IC Z3 S14	258870.1250
12,80		14	124	77	60	45	12.80 5xD IC Z3 S14	258870.1280
13,00		14	124	77	60	45	13.00 5xD IC Z3 S14	258870.1300

d1 (mm)	d1 (inch)	d2	l1	l2	l3	l4	Description	Item no.
13,50		14	124	77	60	45	13.50 5xD IC Z3 S14	258870.1350
13,80		14	124	77	60	45	13.80 5xD IC Z3 S14	258870.1380
14,00		14	124	77	60	45	14.00 5xD IC Z3 S14	258870.1400
14,29	9/16	16	133	83	63	48	14.29 5xD IC Z3 S16	258870.1429
14,50		16	133	83	63	48	14.50 5xD IC Z3 S16	258870.1450
14,68	37/64	16	133	83	63	48	14.68 5xD IC Z3 S16	258870.1468
14,80		16	133	83	63	48	14.80 5xD IC Z3 S16	258870.1480
15,00		16	133	83	63	48	15.00 5xD IC Z3 S16	258870.1500
15,08	19/32	16	133	83	63	48	15.08 5xD IC Z3 S16	258870.1508
15,50		16	133	83	63	48	15.50 5xD IC Z3 S16	258870.1550
15,80		16	133	83	63	48	15.80 5xD IC Z3 S16	258870.1580
15,88	5/8	16	133	83	63	48	15.88 5xD IC Z3 S16	258870.1588
16,00		16	133	83	63	48	16.00 5xD IC Z3 S16	258870.1600
16,50		18	143	93	71	48	16.50 5xD IC Z3 S18	258870.1650
16,67	21/32	18	143	93	71	48	16.67 5xD IC Z3 S18	258870.1667
16,80		18	143	93	71	48	16.80 5xD IC Z3 S18	258870.1680
17,00		18	143	93	71	48	17.00 5xD IC Z3 S18	258870.1700
17,46	11/16	18	143	93	71	48	17.46 5xD IC Z3 S18	258870.1746
17,50		18	143	93	71	48	17.50 5xD IC Z3 S18	258870.1750
17,80		18	143	93	71	48	17.80 5xD IC Z3 S18	258870.1780
17,86	45/64	18	143	93	71	48	17.86 5xD IC Z3 S18	258870.1786
18,00		18	143	93	71	48	18.00 5xD IC Z3 S18	258870.1800
18,26	23/32	20	153	101	77	50	18.26 5xD IC Z3 S20	258870.1826
18,50		20	153	101	77	50	18.50 5xD IC Z3 S20	258870.1850
18,80		20	153	101	77	50	18.80 5xD IC Z3 S20	258870.1880
19,00		20	153	101	77	50	19.00 5xD IC Z3 S20	258870.1900
19,05	3/4	20	153	101	77	50	19.05 5xD IC Z3 S20	258870.1905
19,50		20	153	101	77	50	19.50 5xD IC Z3 S20	258870.1950
19,80		20	153	101	77	50	19.80 5xD IC Z3 S20	258870.1980
20,00		20	153	101	77	50	20.00 5xD IC Z3 S20	258870.2000

8xD

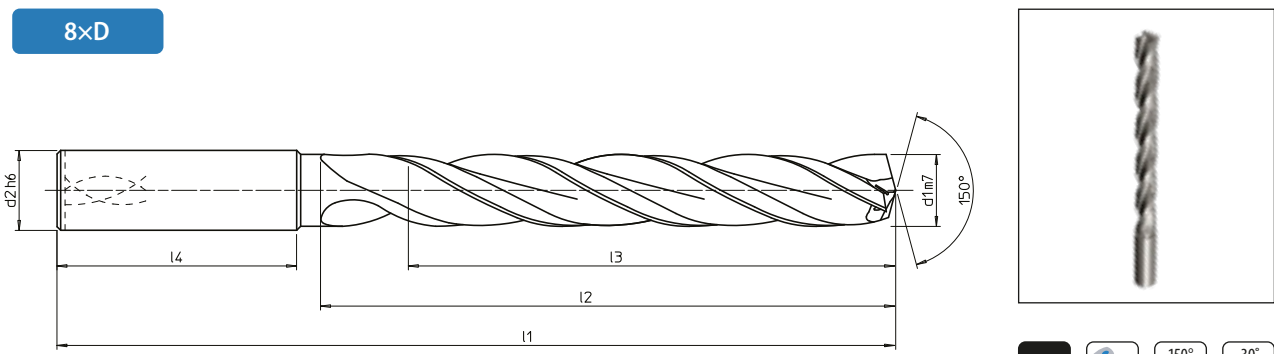

Carbide

Polished

150°

30°

h6

m7

■ Optimum solution for Non-Ferrous Metal

d1 (mm)	d1 (inch)	d2	l1	l2	l3	l4	Description	Item no.
4,00		6	81	43	36	36	4.00 8xD IC Z3 S6	258871.0400
4,10		6	81	43	36	36	4.10 8xD IC Z3 S6	258871.0410
4,20		6	81	43	36	36	4.20 8xD IC Z3 S6	258871.0420
4,30		6	81	43	36	36	4.30 8xD IC Z3 S6	258871.0430
4,37	11/64	6	81	43	36	36	4.37 8xD IC Z3 S6	258871.0437
4,40		6	81	43	36	36	4.40 8xD IC Z3 S6	258871.0440
4,50		6	81	43	36	36	4.50 8xD IC Z3 S6	258871.0450
4,60		6	81	43	36	36	4.60 8xD IC Z3 S6	258871.0460
4,70		6	81	43	36	36	4.70 8xD IC Z3 S6	258871.0470
4,76	3/16	6	95	57	48	36	4.76 8xD IC Z3 S6	258871.0476
4,80		6	95	57	48	36	4.80 8xD IC Z3 S6	258871.0480
4,90		6	95	57	48	36	4.90 8xD IC Z3 S6	258871.0490
5,00		6	95	57	48	36	5.00 8xD IC Z3 S6	258871.0500
5,10		6	95	57	48	36	5.10 8xD IC Z3 S6	258871.0510
5,16	13/64	6	95	57	48	36	5.16 8xD IC Z3 S6	258871.0516
5,20		6	95	57	48	36	5.20 8xD IC Z3 S6	258871.0520
5,30		6	95	57	48	36	5.30 8xD IC Z3 S6	258871.0530
5,40		6	95	57	48	36	5.40 8xD IC Z3 S6	258871.0540
5,50		6	95	57	48	36	5.50 8xD IC Z3 S6	258871.0550
5,56	7/32	6	95	57	48	36	5.56 8xD IC Z3 S6	258871.0556
5,60		6	95	57	48	36	5.60 8xD IC Z3 S6	258871.0560
5,70		6	95	57	48	36	5.70 8xD IC Z3 S6	258871.0570
5,80		6	95	57	48	36	5.80 8xD IC Z3 S6	258871.0580
5,90		6	95	57	48	36	5.90 8xD IC Z3 S6	258871.0590
5,95	15/64	6	95	57	48	36	5.95 8xD IC Z3 S6	258871.0595
6,00		6	95	57	48	36	6.00 8xD IC Z3 S6	258871.0600
6,10		8	114	76	64	36	6.10 8xD IC Z3 S8	258871.0610
6,20		8	114	76	64	36	6.20 8xD IC Z3 S8	258871.0620
6,30		8	114	76	64	36	6.30 8xD IC Z3 S8	258871.0630
6,35	1/4	8	114	76	64	36	6.35 8xD IC Z3 S8	258871.0635
6,40		8	114	76	64	36	6.40 8xD IC Z3 S8	258871.0640
6,50		8	114	76	64	36	6.50 8xD IC Z3 S8	258871.0650
6,60		8	114	76	64	36	6.60 8xD IC Z3 S8	258871.0660
6,70		8	114	76	64	36	6.70 8xD IC Z3 S8	258871.0670

d1 (mm)	d1 (inch)	d2	l1	l2	l3	l4	Description	Item no.
6,75	17/64	8	114	76	64	36	6.75 8xD IC Z3 S8	258871.0675
6,80		8	114	76	64	36	6.80 8xD IC Z3 S8	258871.0680
6,90		8	114	76	64	36	6.90 8xD IC Z3 S8	258871.0690
7,00		8	114	76	64	36	7.00 8xD IC Z3 S8	258871.0700
7,10		8	114	76	64	36	7.10 8xD IC Z3 S8	258871.0710
7,14	9/32	8	114	76	64	36	7.14 8xD IC Z3 S8	258871.0714
7,20		8	114	76	64	36	7.20 8xD IC Z3 S8	258871.0720
7,30		8	114	76	64	36	7.30 8xD IC Z3 S8	258871.0730
7,40		8	114	76	64	36	7.40 8xD IC Z3 S8	258871.0740
7,50		8	114	76	64	36	7.50 8xD IC Z3 S8	258871.0750
7,54	19/64	8	114	76	64	36	7.54 8xD IC Z3 S8	258871.0754
7,60		8	114	76	64	36	7.60 8xD IC Z3 S8	258871.0760
7,70		8	114	76	64	36	7.70 8xD IC Z3 S8	258871.0770
7,80		8	114	76	64	36	7.80 8xD IC Z3 S8	258871.0780
7,90		8	114	76	64	36	7.90 8xD IC Z3 S8	258871.0790
7,94	5/16	8	114	76	64	36	7.94 8xD IC Z3 S8	258871.0794
8,00		8	114	76	64	36	8.00 8xD IC Z3 S8	258871.0800
8,10		10	142	95	80	40	8.10 8xD IC Z3 S10	258871.0810
8,20		10	142	95	80	40	8.20 8xD IC Z3 S10	258871.0820
8,30		10	142	95	80	40	8.30 8xD IC Z3 S10	258871.0830
8,33	21/64	10	142	95	80	40	8.33 8xD IC Z3 S10	258871.0833
8,40		10	142	95	80	40	8.40 8xD IC Z3 S10	258871.0840
8,50		10	142	95	80	40	8.50 8xD IC Z3 S10	258871.0850
8,60		10	142	95	80	40	8.60 8xD IC Z3 S10	258871.0860
8,70		10	142	95	80	40	8.70 8xD IC Z3 S10	258871.0870
8,73	11/32	10	142	95	80	40	8.73 8xD IC Z3 S10	258871.0873
8,80		10	142	95	80	40	8.80 8xD IC Z3 S10	258871.0880
8,90		10	142	95	80	40	8.90 8xD IC Z3 S10	258871.0890
9,00		10	142	95	80	40	9.00 8xD IC Z3 S10	258871.0900
9,10		10	142	95	80	40	9.10 8xD IC Z3 S10	258871.0910
9,13	23/64	10	142	95	80	40	9.13 8xD IC Z3 S10	258871.0913
9,20		10	142	95	80	40	9.20 8xD IC Z3 S10	258871.0920
9,30		10	142	95	80	40	9.30 8xD IC Z3 S10	258871.0930
9,40		10	142	95	80	40	9.40 8xD IC Z3 S10	258871.0940

8×D

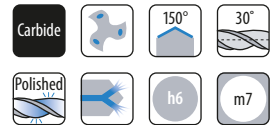
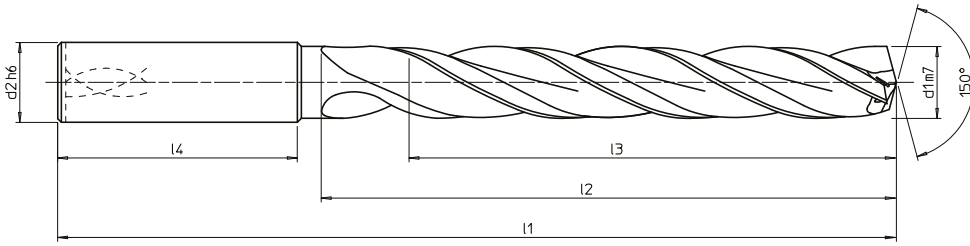

■ Optimum solution for Non-Ferrous Metal

d1 (mm)	d1 (inch)	d2	l1	l2	l3	l4	Description	Item no.
9,50		10	142	95	80	40	9.50 8×D IC Z3 S10	258871.0950
9,53	3/8	10	142	95	80	40	9.53 8×D IC Z3 S10	258871.0953
9,60		10	142	95	80	40	9.60 8×D IC Z3 S10	258871.0960
9,70		10	142	95	80	40	9.70 8×D IC Z3 S10	258871.0970
9,80		10	142	95	80	40	9.80 8×D IC Z3 S10	258871.0980
9,90		10	142	95	80	40	9.90 8×D IC Z3 S10	258871.0990
9,92	25/64	10	142	95	80	40	9.92 8×D IC Z3 S10	258871.0992
10,00		10	142	95	80	40	10.00 8×D IC Z3 S10	258871.1000
10,10		12	162	114	96	45	10.10 8×D IC Z3 S12	258871.1010
10,20		12	162	114	96	45	10.20 8×D IC Z3 S12	258871.1020
10,30		12	162	114	96	45	10.30 8×D IC Z3 S12	258871.1030
10,32	13/32	12	162	114	96	45	10.32 8×D IC Z3 S12	258871.1032
10,40		12	162	114	96	45	10.40 8×D IC Z3 S12	258871.1040
10,50		12	162	114	96	45	10.50 8×D IC Z3 S12	258871.1050
10,60		12	162	114	96	45	10.60 8×D IC Z3 S12	258871.1060
10,70		12	162	114	96	45	10.70 8×D IC Z3 S12	258871.1070
10,72	27/64	12	162	114	96	45	10.72 8×D IC Z3 S12	258871.1072
10,80		12	162	114	96	45	10.80 8×D IC Z3 S12	258871.1080
10,90		12	162	114	96	45	10.90 8×D IC Z3 S12	258871.1090
11,00		12	162	114	96	45	11.00 8×D IC Z3 S12	258871.1100
11,10		12	162	114	96	45	11.10 8×D IC Z3 S12	258871.1110
11,11	7/16	12	162	114	96	45	11.11 8×D IC Z3 S12	258871.1111
11,20		12	162	114	96	45	11.20 8×D IC Z3 S12	258871.1120
11,30		12	162	114	96	45	11.30 8×D IC Z3 S12	258871.1130
11,40		12	162	114	96	45	11.40 8×D IC Z3 S12	258871.1140
11,50		12	162	114	96	45	11.50 8×D IC Z3 S12	258871.1150
11,60		12	162	114	96	45	11.60 8×D IC Z3 S12	258871.1160
11,70		12	162	114	96	45	11.70 8×D IC Z3 S12	258871.1170
11,80		12	162	114	96	45	11.80 8×D IC Z3 S12	258871.1180
11,90		12	162	114	96	45	11.90 8×D IC Z3 S12	258871.1190
12,00		12	162	114	96	45	12.00 8×D IC Z3 S12	258871.1200
12,50		14	178	133	112	45	12.50 8×D IC Z3 S14	258871.1250
12,80		14	178	133	112	45	12.80 8×D IC Z3 S14	258871.1280
13,00		14	178	133	112	45	13.00 8×D IC Z3 S14	258871.1300

d1 (mm)	d1 (inch)	d2	l1	l2	l3	l4	Description	Item no.
13,50		14	178	133	112	45	13.50 8×D IC Z3 S14	258871.1350
13,80		14	178	133	112	45	13.80 8×D IC Z3 S14	258871.1380
14,00		14	178	133	112	45	14.00 8×D IC Z3 S14	258871.1400
14,29	9/16	16	203	152	128	48	14.29 8×D IC Z3 S16	258871.1429
14,50		16	203	152	128	48	14.50 8×D IC Z3 S16	258871.1450
14,68	37/64	16	203	152	128	48	14.68 8×D IC Z3 S16	258871.1468
14,80		16	203	152	128	48	14.80 8×D IC Z3 S16	258871.1480
15,00		16	203	152	128	48	15.00 8×D IC Z3 S16	258871.1500
15,08	19/32	16	203	152	128	48	15.08 8×D IC Z3 S16	258871.1508
15,50		16	203	152	128	48	15.50 8×D IC Z3 S16	258871.1550
15,80		16	203	152	128	48	15.80 8×D IC Z3 S16	258871.1580
15,88	5/8	16	203	152	128	48	15.88 8×D IC Z3 S16	258871.1588
16,00		16	203	152	128	48	16.00 8×D IC Z3 S16	258871.1600
16,50		18	222	152	128	48	16.50 8×D IC Z3 S18	258871.1650
16,67	21/32	18	222	152	128	48	16.67 8×D IC Z3 S18	258871.1667
16,80		18	222	152	128	48	16.80 8×D IC Z3 S18	258871.1680
17,00		18	222	152	128	48	17.00 8×D IC Z3 S18	258871.1700
17,46	11/16	18	222	152	128	48	17.46 8×D IC Z3 S18	258871.1746
17,50		18	222	152	128	48	17.50 8×D IC Z3 S18	258871.1750
17,80		18	222	152	128	48	17.80 8×D IC Z3 S18	258871.1780
17,86	45/64	18	222	152	128	48	17.86 8×D IC Z3 S18	258871.1786
18,00		18	222	152	128	48	18.00 8×D IC Z3 S18	258871.1800
18,26	23/32	20	243	190	160	50	18.26 8×D IC Z3 S20	258871.1826
18,50		20	243	190	160	50	18.50 8×D IC Z3 S20	258871.1850
18,80		20	243	190	160	50	18.80 8×D IC Z3 S20	258871.1880
19,00		20	243	190	160	50	19.00 8×D IC Z3 S20	258871.1900
19,05	3/4	20	243	190	160	50	19.05 8×D IC Z3 S20	258871.1905
19,50		20	243	190	160	50	19.50 8×D IC Z3 S20	258871.1950
19,80		20	243	190	160	50	19.80 8×D IC Z3 S20	258871.1980
20,00		20	243	190	160	50	20.00 8×D IC Z3 S20	258871.2000

12×D

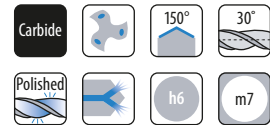
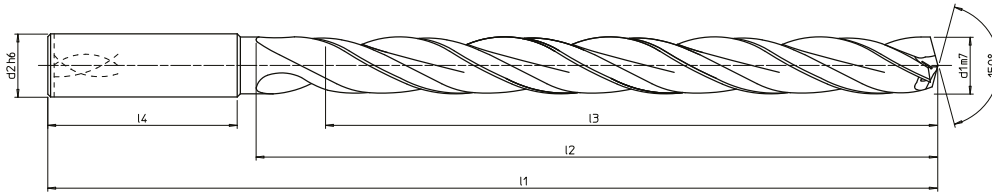

■ Optimum solution for Non-Ferrous Metal

d1 (mm)	d1 (inch)	d2	l1	l2	l3	l4	Description	Item no.
4,00		6	102	64	58	36	4.00 12×D IC Z3 S6	258872.0400
4,10		6	102	64	58	36	4.10 12×D IC Z3 S6	258872.0410
4,20		6	102	64	58	36	4.20 12×D IC Z3 S6	258872.0420
4,30		6	102	64	58	36	4.30 12×D IC Z3 S6	258872.0430
4,37	11/64	6	102	64	58	36	4.37 12×D IC Z3 S6	258872.0437
4,40		6	102	64	58	36	4.40 12×D IC Z3 S6	258872.0440
4,50		6	102	64	58	36	4.50 12×D IC Z3 S6	258872.0450
4,60		6	102	64	58	36	4.60 12×D IC Z3 S6	258872.0460
4,70		6	102	64	58	36	4.70 12×D IC Z3 S6	258872.0470
4,76	3/16	6	116	78	70	36	4.76 12×D IC Z3 S6	258872.0476
4,80		6	116	78	70	36	4.80 12×D IC Z3 S6	258872.0480
4,90		6	116	78	70	36	4.90 12×D IC Z3 S6	258872.0490
5,00		6	116	78	70	36	5.00 12×D IC Z3 S6	258872.0500
5,10		6	116	78	70	36	5.10 12×D IC Z3 S6	258872.0510
5,16	13/64	6	116	78	70	36	5.16 12×D IC Z3 S6	258872.0516
5,20		6	116	78	70	36	5.20 12×D IC Z3 S6	258872.0520
5,30		6	116	78	70	36	5.30 12×D IC Z3 S6	258872.0530
5,40		6	116	78	70	36	5.40 12×D IC Z3 S6	258872.0540
5,50		6	116	78	70	36	5.50 12×D IC Z3 S6	258872.0550
5,56	7/32	6	116	78	70	36	5.56 12×D IC Z3 S6	258872.0556
5,60		6	116	78	70	36	5.60 12×D IC Z3 S6	258872.0560
5,70		6	116	78	70	36	5.70 12×D IC Z3 S6	258872.0570
5,80		6	116	78	70	36	5.80 12×D IC Z3 S6	258872.0580
5,90		6	116	78	70	36	5.90 12×D IC Z3 S6	258872.0590
5,95	15/64	6	116	78	70	36	5.95 12×D IC Z3 S6	258872.0595
6,00		6	116	78	70	36	6.00 12×D IC Z3 S6	258872.0600
6,10		8	146	108	94	36	6.10 12×D IC Z3 S8	258872.0610
6,20		8	146	108	94	36	6.20 12×D IC Z3 S8	258872.0620
6,30		8	146	108	94	36	6.30 12×D IC Z3 S8	258872.0630
6,35	1/4	8	146	108	94	36	6.35 12×D IC Z3 S8	258872.0635
6,40		8	146	108	94	36	6.40 12×D IC Z3 S8	258872.0640
6,50		8	146	108	94	36	6.50 12×D IC Z3 S8	258872.0650
6,60		8	146	108	94	36	6.60 12×D IC Z3 S8	258872.0660
6,70		8	146	108	94	36	6.70 12×D IC Z3 S8	258872.0670

d1 (mm)	d1 (inch)	d2	l1	l2	l3	l4	Description	Item no.
6,75	17/64	8	146	108	94	36	6.75 12×D IC Z3 S8	258872.0675
6,80		8	146	108	94	36	6.80 12×D IC Z3 S8	258872.0680
6,90		8	146	108	94	36	6.90 12×D IC Z3 S8	258872.0690
7,00		8	146	108	94	36	7.00 12×D IC Z3 S8	258872.0700
7,10		8	146	108	94	36	7.10 12×D IC Z3 S8	258872.0710
7,14	9/32	8	146	108	94	36	7.14 12×D IC Z3 S8	258872.0714
7,20		8	146	108	94	36	7.20 12×D IC Z3 S8	258872.0720
7,30		8	146	108	94	36	7.30 12×D IC Z3 S8	258872.0730
7,40		8	146	108	94	36	7.40 12×D IC Z3 S8	258872.0740
7,50		8	146	108	94	36	7.50 12×D IC Z3 S8	258872.0750
7,54	19/64	8	146	108	94	36	7.54 12×D IC Z3 S8	258872.0754
7,60		8	146	108	94	36	7.60 12×D IC Z3 S8	258872.0760
7,70		8	146	108	94	36	7.70 12×D IC Z3 S8	258872.0770
7,80		8	146	108	94	36	7.80 12×D IC Z3 S8	258872.0780
7,90		8	146	108	94	36	7.90 12×D IC Z3 S8	258872.0790
7,94	5/16	8	146	108	94	36	7.94 12×D IC Z3 S8	258872.0794
8,00		8	146	108	94	36	8.00 12×D IC Z3 S8	258872.0800
8,10		10	162	120	110	40	8.10 12×D IC Z3 S10	258872.0810
8,20		10	162	120	110	40	8.20 12×D IC Z3 S10	258872.0820
8,30		10	162	120	110	40	8.30 12×D IC Z3 S10	258872.0830
8,33	21/64	10	162	120	110	40	8.33 12×D IC Z3 S10	258872.0833
8,40		10	162	120	110	40	8.40 12×D IC Z3 S10	258872.0840
8,50		10	162	120	110	40	8.50 12×D IC Z3 S10	258872.0850
8,60		10	162	120	110	40	8.60 12×D IC Z3 S10	258872.0860
8,70		10	162	120	110	40	8.70 12×D IC Z3 S10	258872.0870
8,73	11/32	10	162	120	110	40	8.73 12×D IC Z3 S10	258872.0873
8,80		10	162	120	110	40	8.80 12×D IC Z3 S10	258872.0880
8,90		10	162	120	110	40	8.90 12×D IC Z3 S10	258872.0890
9,00		10	162	120	110	40	9.00 12×D IC Z3 S10	258872.0900
9,10		10	162	120	110	40	9.10 12×D IC Z3 S10	258872.0910
9,13	23/64	10	162	120	110	40	9.13 12×D IC Z3 S10	258872.0913
9,20		10	162	120	110	40	9.20 12×D IC Z3 S10	258872.0920
9,30		10	162	120	110	40	9.30 12×D IC Z3 S10	258872.0930
9,40		10	162	120	110	40	9.40 12×D IC Z3 S10	258872.0940

12×D

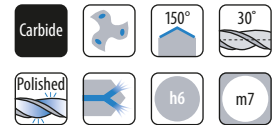
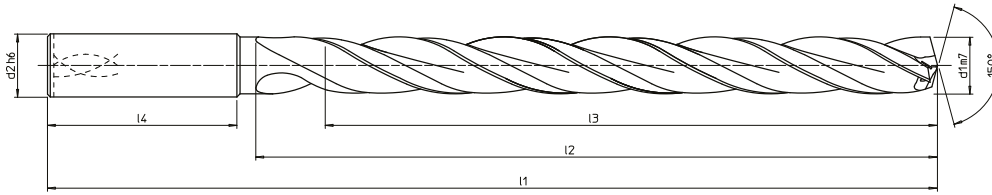

■ Optimum solution for Non-Ferrous Metal

d1 (mm)	d1 (inch)	d2	L1	L2	L3	L4	Description	Item no.
9,50	10	162	120	110	40	9.50 12×D IC Z3 S10	258872.0950	
9,53	3/8	10	162	120	110	40	9.53 12×D IC Z3 S10	258872.0953
9,60	10	162	120	110	40	9.60 12×D IC Z3 S10	258872.0960	
9,70	10	162	120	110	40	9.70 12×D IC Z3 S10	258872.0970	
9,80	10	162	120	110	40	9.80 12×D IC Z3 S10	258872.0980	
9,90	10	162	120	110	40	9.90 12×D IC Z3 S10	258872.0990	
9,92	25/64	10	162	120	110	40	9.92 12×D IC Z3 S10	258872.0992
10,00	10	162	120	110	40	10.00 12×D IC Z3 S10	258872.1000	
10,10	12	204	156	142	45	10.10 12×D IC Z3 S12	258872.1010	
10,20	12	204	156	142	45	10.20 12×D IC Z3 S12	258872.1020	
10,30	12	204	156	142	45	10.30 12×D IC Z3 S12	258872.1030	
10,32	13/32	12	204	156	142	45	10.32 12×D IC Z3 S12	258872.1032
10,40	12	204	156	142	45	10.40 12×D IC Z3 S12	258872.1040	
10,50	12	204	156	142	45	10.50 12×D IC Z3 S12	258872.1050	
10,60	12	204	156	142	45	10.60 12×D IC Z3 S12	258872.1060	
10,70	12	204	156	142	45	10.70 12×D IC Z3 S12	258872.1070	
10,72	27/64	12	204	156	142	45	10.72 12×D IC Z3 S12	258872.1072
10,80	12	204	156	142	45	10.80 12×D IC Z3 S12	258872.1080	
10,90	12	204	156	142	45	10.90 12×D IC Z3 S12	258872.1090	
11,00	12	204	156	142	45	11.00 12×D IC Z3 S12	258872.1100	
11,10	12	204	156	142	45	11.10 12×D IC Z3 S12	258872.1110	
11,11	7/16	12	204	156	142	45	11.11 12×D IC Z3 S12	258872.1111
11,20	12	204	156	142	45	11.20 12×D IC Z3 S12	258872.1120	
11,30	12	204	156	142	45	11.30 12×D IC Z3 S12	258872.1130	
11,40	12	204	156	142	45	11.40 12×D IC Z3 S12	258872.1140	
11,50	12	204	156	142	45	11.50 12×D IC Z3 S12	258872.1150	
11,60	12	204	156	142	45	11.60 12×D IC Z3 S12	258872.1160	
11,70	12	204	156	142	45	11.70 12×D IC Z3 S12	258872.1172	
11,80	12	204	156	142	45	11.80 12×D IC Z3 S12	258872.1180	
11,90	12	204	156	142	45	11.90 12×D IC Z3 S12	258872.1190	
12,00	12	204	156	142	45	12.00 12×D IC Z3 S12	258872.1200	
12,50	14	230	182	166	45	12.50 12×D IC Z3 S14	258872.1250	
12,80	14	230	182	166	45	12.80 12×D IC Z3 S14	258872.1280	
13,00	14	230	182	166	45	13.00 12×D IC Z3 S14	258872.1300	

d1 (mm)	d1 (inch)	d2	L1	L2	L3	L4	Description	Item no.
13,50	14	230	182	166	45	13.50 12×D IC Z3 S14	258872.1350	
13,80	14	230	182	166	45	13.80 12×D IC Z3 S14	258872.1380	
14,00	14	230	182	166	45	14.00 12×D IC Z3 S14	258872.1400	
14,29	9/16	16	260	208	192	48	14.29 12×D IC Z3 S16	258872.1429
14,50	16	260	208	192	48	14.50 12×D IC Z3 S16	258872.1450	
14,68	37/64	16	260	208	192	48	14.68 12×D IC Z3 S16	258872.1468
14,80	16	260	208	192	48	14.80 12×D IC Z3 S16	258872.1480	
15,00	16	260	208	192	48	15.00 12×D IC Z3 S16	258872.1500	
15,08	19/32	16	260	208	192	48	15.08 12×D IC Z3 S16	258872.1508
15,50	16	260	208	192	48	15.50 12×D IC Z3 S16	258872.1550	
15,80	16	260	208	192	48	15.80 12×D IC Z3 S16	258872.1580	
15,88	5/8	16	260	208	192	48	15.88 12×D IC Z3 S16	258872.1588
16,00	16	260	208	192	48	16.00 12×D IC Z3 S16	258872.1600	
16,50	18	285	234	216	48	16.50 12×D IC Z3 S18	258872.1650	
16,67	21/32	18	285	234	216	48	16.67 12×D IC Z3 S18	258872.1667
16,80	18	285	234	216	48	16.80 12×D IC Z3 S18	258872.1680	
17,00	18	285	234	216	48	17.00 12×D IC Z3 S18	258872.1700	
17,46	11/16	18	285	234	216	48	17.46 12×D IC Z3 S18	258872.1746
17,50	18	285	234	216	48	17.50 12×D IC Z3 S18	258872.1750	
17,80	18	285	234	216	48	17.80 12×D IC Z3 S18	258872.1780	
17,86	45/64	18	285	234	216	48	17.86 12×D IC Z3 S18	258872.1786
18,00	18	285	234	216	48	18.00 12×D IC Z3 S18	258872.1800	
18,26	23/32	20	310	258	240	50	18.26 12×D IC Z3 S20	258872.1826
18,50	20	310	258	240	50	18.50 12×D IC Z3 S20	258872.1850	
18,80	20	310	258	240	50	18.80 12×D IC Z3 S20	258872.1880	
19,00	20	310	258	240	50	19.00 12×D IC Z3 S20	258872.1900	
19,05	3/4	20	310	258	240	50	19.05 12×D IC Z3 S20	258872.1905
19,50	20	310	258	240	50	19.50 12×D IC Z3 S20	258872.1950	
19,80	20	310	258	240	50	19.80 12×D IC Z3 S20	258872.1980	
20,00	20	310	258	240	50	20.00 12×D IC Z3 S20	258872.2000	

Corporate Motto: "Respect the Divine and Love People"

敬天愛人

Preserve the spirit to work fairly and honourably,
respecting people, our work, our company
and our global community.



The cutting edge of technology

The global Kyocera Group develops unique technologies and applies its vision to create valuable products that the markets continuously seek.

UM RapidDrill

Use recommended cutting speed data to maintain optimum quality and durability



Cutting data Recommended

UMC*	Material	Cutting speed Vc [m/min]				Feed F=mm/rev				
		Internal coolant	External coolant	MQL	Air	Ø4,0	Ø5,5	Ø7,5	Ø10,5	Ø20,0
N1.1	Aluminium / Non-alloy and alloy / < 3% Si	300	200	250	-	0,42	0,53	0,66	0,82	1,15
N1.2	Aluminium / Alloy / ≤ 7% Si	250	180	200	-	0,53	0,68	0,85	1,07	1,52
N1.3	Aluminium / Alloy / > 7-12% Si	220	150	180	-	0,53	0,68	0,85	1,07	1,52
N1.4	Aluminium / Alloy / > 12% Si	180	120	150	-	0,53	0,68	0,85	1,07	1,52

* *Unimerc Material Classification.*

Note: Recommended cutting conditions above is for 5xD type. As drilling depth increases (5xD ⇒ 8xD ⇒ 12xD), feed rates should be reduced.
 Recommended feed rate: 5xD type = 100%, 8xD type = 70% or less, 12xD type = 60% or less.
 Recommended cutting speed: 5xD type = 100%, 8xD type = 80% or less, 12xD type = 70% or less.
 Reduce feed rate in order to improve hole quality.

Caution! Pilot drilling for UM RapidDrill 8xD type or deeper

- Please follow recommendations for larger drill depths to maintain maximum hole quality.

1 Make a centre spot

Use UM RapidDrill 5xD type or shorter.
 Centre spot should be at least half of cutting diameter.

2 Drill hole

Use UM RapidDrill 8xD/12xD type or special designed UM RapidDrill above 8xD type.
 Check cutting data above and be aware of reduced cutting speed for larger drilling depths.



Industrial tooling solutions

Kyocera Unimerco is a global manufacturer and distributor, providing standard and customised cutting tool solutions as well as know-how and optimisation guidance for the manufacturing industry.

The company was founded in 1964 and has since expanded into 17 countries, with more than 700 employees.

Today the company is part of the Japan-based Kyocera Corporation.

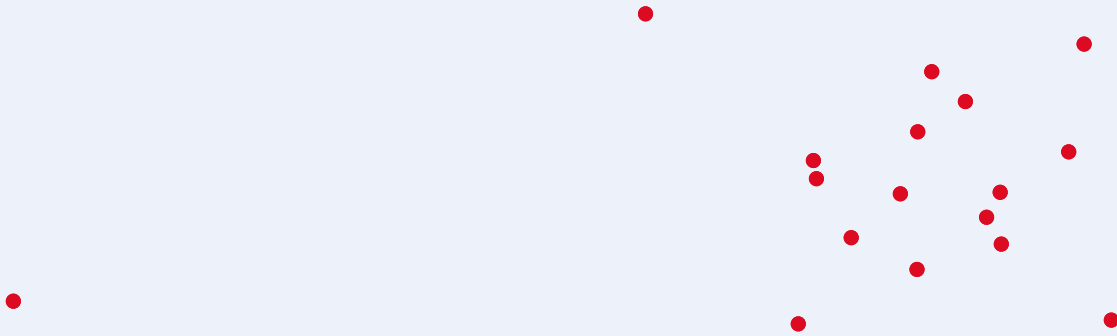

www.kyocera-unimerco.com